KNIGHT
IDEX
IDEX CORPORATION



**ILCS System
Installation Manual**

TABLE OF CONTENTS

Specifications	3
System Overview.....	4
How It Works	4
The System Includes	4
Pre-Installation.....	5
Installation	5
Optional 3-Way Valve.....	6
System Connections Diagram	7
Wiring Diagram (typical system)	8
Wiring Diagram (6900X without pumps)	9
Manifold Components Diagram	10
Spout Assembly Diagram.....	11
Warranty Information.....	12
Knight Locations	12



CAUTION: Wear protective clothing and eyewear when dispensing chemicals or other materials. Observe safety handling instructions (MSDS) of chemical mfrs.



CAUTION: To avoid severe or fatal shock, always disconnect main power when servicing the unit.



CAUTION: When installing any equipment, ensure that all national and local safety, electrical, and plumbing codes are met.

SPECIFICATIONS

Hardware

Voltage — input/output	115 VAC / 60 Hz
Maximum pump outputs	8
Pump cabinet capacity	6
Manifolds (GFP)	(1) 4-port (1) 8-port
Water flush output	1
Solenoid drain output.....	1
Pressure regulator	25 psi

Software

Main access code.....	1
User access code.....	1
User passwords.....	50 or 400
Total formulas.....	99
Total records retained (before writing over information)	6000
Maximum gallon per pump	300
Maximum flowrate per pump	25 gpm
Minimum flowrate per pump	3 ounces
Maximum chemical per shift	13,000 gallons
Maximum chemical usage per report.....	99,999
Maximum peristaltic pump motor run time	12 minutes
Maximum gallon per summary report	99,999
Minimum on cycle time	1 second
Minimum flush time.....	2 seconds
Flush valve (optional) delay	2 seconds
Maximum chemical cost per report.....	\$99,999.00

SYSTEM OVERVIEW

The Industrial Liquid Control System (ILCS) is an automated chemical control system that accumulates critical usage data of chemicals used for cleaning in food plants. Using the very latest concepts in process control technology, the ILCS provides key benefits:

- **Ease of Operation:** ILCS eliminates messy drum pumps and the need to lift heavy drums of chemical that can splash hazardous chemicals or spill on the ground. After entering the user password, with a push of the start button, a pre-determined formula dispenses into a gerry can or other container.
- **Cost Control:** ILCS does more than just dispense chemicals. It gives all users the opportunity to get real control of every aspect of day-to-day operation.
- **Safety:** The system limits the worker from coming in contact with concentrated cleaners by automatically dispensing products into standard containers to use throughout the food plant.
- **Environmental Safety:** By dispensing directly to a product container the system limits spillage or waste. Chemical concentrations and volumes are computer controlled to eliminate waste and guarantee the exact amount of product used for each cleaning process.
- **Main control:** The ILCS control panel allows direct programming of the system at the keypad, and also stores report information. PC interface to the control panel expands the data management capabilities.

HOW IT WORKS

Total of 99 formula capability provides multiple chemical dispensing. Formula names and numbers are displayed on the control panel for easy identification. Operators enter their individual user password at the control panel to begin a dispensing cycle, and a built-in key switch prevents unauthorized dispensing.

After selecting the desired formula, the operator pushes the start switch for one second to start the feed cycle. Use of the flush feature is recommended to prevent cross contamination of chemicals. If necessary, the emergency stop switch can be used for an immediate shut-down of all system functions.

Built-in flush manifolds allow all pumps to dispense through a single discharge spout assembly. A pressure regulator with gauge is used to control fill pressure. Use of the optional 3-way valve enables the system to divert flush water to a drain, or product containers.

NOTE: Systems without flush manifolds are designed to dispense chemicals directly to point of use without water to flush or dilute the solution.

THE SYSTEM INCLUDES

Hardware:

- Watertight control panel (pre-wired)
- Pump cabinet with up to 6 pumps mounted
- Accessory kit complete with mounting bracket, spout assembly, pick up tube and spare parts

If equipped with Flush Manifold:

- Dual flush manifold system plumbed and mounted
- Eight injection valve assemblies, six on pump inlet to manifolds, two on water inlet to flush manifolds
- Pressure regulator and gauge preset to 25 psi
- Water solenoid for incoming flush water

Software:

- Up to eight pump capability
- 99 formula capability
- 50 or 400 user passwords
- Records critical data usage

Options (not included):

- Stainless steel container shelf
- Satellite pumps
- Air operated 3-Way Valve assembly (ILCS can be ordered with this option installed).

The 3-Way Valve is designed to divert flow of the flush water from the chemical flush manifolds to a drain. Flushing the manifolds after chemicals are injected prevents potentially dangerous mixing of non-compatible chemicals in the chemical discharge line, chemical receptacle or the container shelf.

PRE-INSTALLATION

Before the equipment is installed, you should survey the installation site thoroughly. Listed below are some of the factors to consider when picking your location.

- ❑ Electrical — requires 115 VAC/60 Hz power source (20 amp service recommended).
- ❑ Water Service — system requires ambient water service to flush manifold (if so equipped). Recommended minimum 25 PSI flow pressure.
- ❑ Wall surface — unit weighs approx. 150 lbs.
- ❑ Floor Drain — system has flush cycle that allows you to flush to a drain (if equipped with flush manifold and optional 3-way valve).
- ❑ Chemicals — unit should be mounted close to the chemical tanks. For bulk tank installations, pumps must be placed on, or near tanks.
- ❑ Work Area — the unit should be mounted in centralized area to work areas.
- ❑ Air Service — for installations with air pumps and/or 3-Way Valves, available air pressure should be 12 SCFM. Check specification of air compressor on site for adequate air flow.

INSTALLATION

Once you have considered the pre-installation items you are ready to mount the unit.

- (1) Install mounting brackets on the wall above the tanks of chemical that will be dispensed through the unit. Mounting bracket must be installed to mate with the mounting bracket on the back of the ILCS system. Use proper mounting hardware and utilize appropriate mounting techniques to meet all local building codes and provide a safe work environment.
- (2) Lift the pump cabinet high enough so that the bracket on the back of the pump cabinet is higher than the bracket on the wall. Lower the pump cabinet bracket down onto the wall bracket until the pump cabinet rests freely on the mounting bracket.
- (3) Mount the control panel on the wall next to the pump cabinet at a height that all users can access and read the display screen.
- (4) Install the suction tubing on each pump. Use the pickup tube to prevent tubing from curling up in tank. Drop the tube in each tank.
- (5) If no flush manifolds are used, connect discharge tubing from each pump to the point of use.

With Flush Manifolds (bolded numbers)

- (6)** Hook up the water connection to the water inlet adapter.
- (7)** See page 10 for spout diagram. Mount the spout bracket on the wall below the pump cabinet, but high enough for the container shelf and gerry can to fit underneath. Insert spout into bracket. Connect the spout assembly tubing to the discharge side of each flush manifold assembly.
- (8)** If the optional three-way valve will be used, see page 6 for installation examples and instructions.
- (9)** Connect main power from a suitable breaker to the terminal block inside the ILCS, and per local wiring codes. An AC line noise filter is included in the electrical wiring of the ILCS (except 6900X).
- (10)** Turn on the air supply if the optional 3-way valve and/or air pumps will be used.
- (11)** Refer to the ILCS programming manual to program the system.

OPTIONAL 3-WAY VALVE

For ILCS systems that are built with the 3-Way Valve option, the air solenoid is already mounted inside the pump cabinet. The activation wires are connected to the proper output on the circuit board (pump 10) and all of the air lines are plumbed to push-connect fittings on the left side of the pump cabinet.

A split discharge system can be setup for separate sanitizer and acid dispensing by using dual 3-Way Valves. This setup maximizes the benefits of the ILCS's separate flush manifolds. The air solenoid can operate both 3-Way Valves through a "tee" connection.

Important installation note:

- The exhaust manifold on the side of the pump cabinet is pre-connected to the air solenoid. Do not modify the exhaust manifold, or block it off in any way!
- (1) Position the 3-Way Valve Assembly near a suitable drain on the discharge side of the ILCS manifolds.
 - (2) Mark 4 hole pattern on the wall surface and drill mounting holes accordingly.
 - (3) Secure 3-Way Valve to wall surface using suitable wall anchors or lag bolts.
 - (4) Secure 1/2" ID discharge tubing to inlet, outlet and drain ports. Use only stainless steel hose clamps to secure tubing.
 - (5) Connect 1/4" poly tubing (provided) from the "air out" fitting on the side of the pump case to the air inlet fitting on the 3-Way Valve. For a 2 valve setup, the air line can be "teed" into the inlet fittings on both 3-Way Valves (example to the right).
 - (6) Connect 1/4" poly tubing (provided) from the air supply to the "air input" fitting on the side of the pump case. A 1/4" NPT push-connect fitting is provided for easy connection to the air supply.

Note: Air supply should be filtered and dried to prevent damage to the 3-Way Valve. Minimum 34 PSI required to operate valve.

After completing the installation of the ILCS system, test the operation of the 3-Way Valve by pressing prime button #9 and #10 simultaneously to activate the water flush and air solenoid.

Water flow should divert to the "drain" port on the 3-Way Valve. Repeat the prime function and check for proper operation and leaks. The air solenoid will exhaust pressure at the end of the cycle. Air exhaust returns the 3-Way Valve to "dispense" orientation.

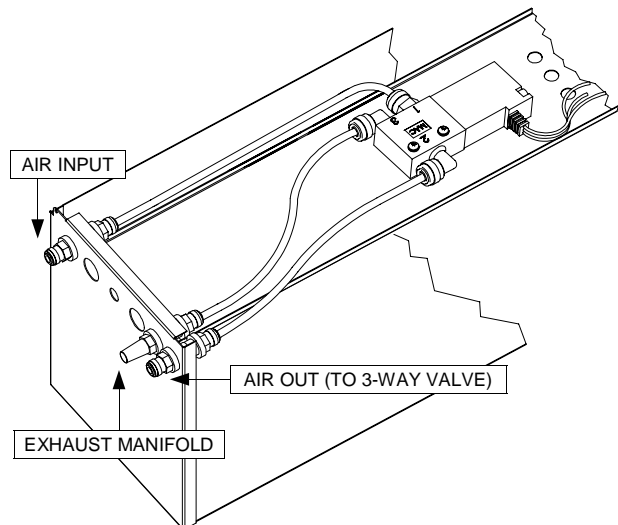
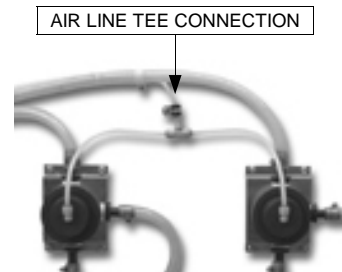
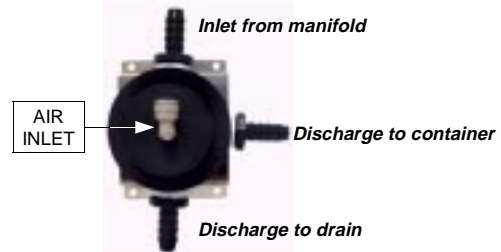
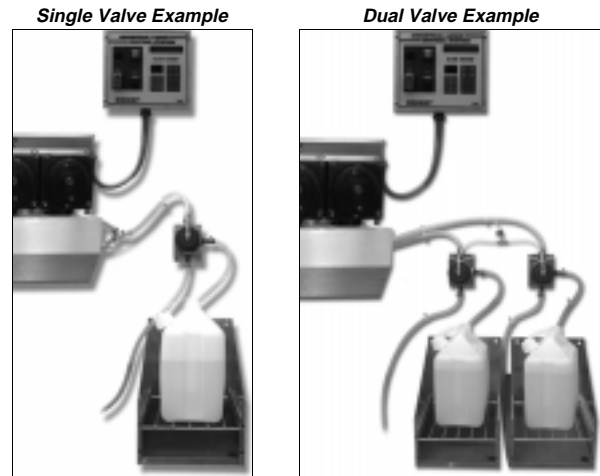

ILCS SYSTEM CONNECTIONS

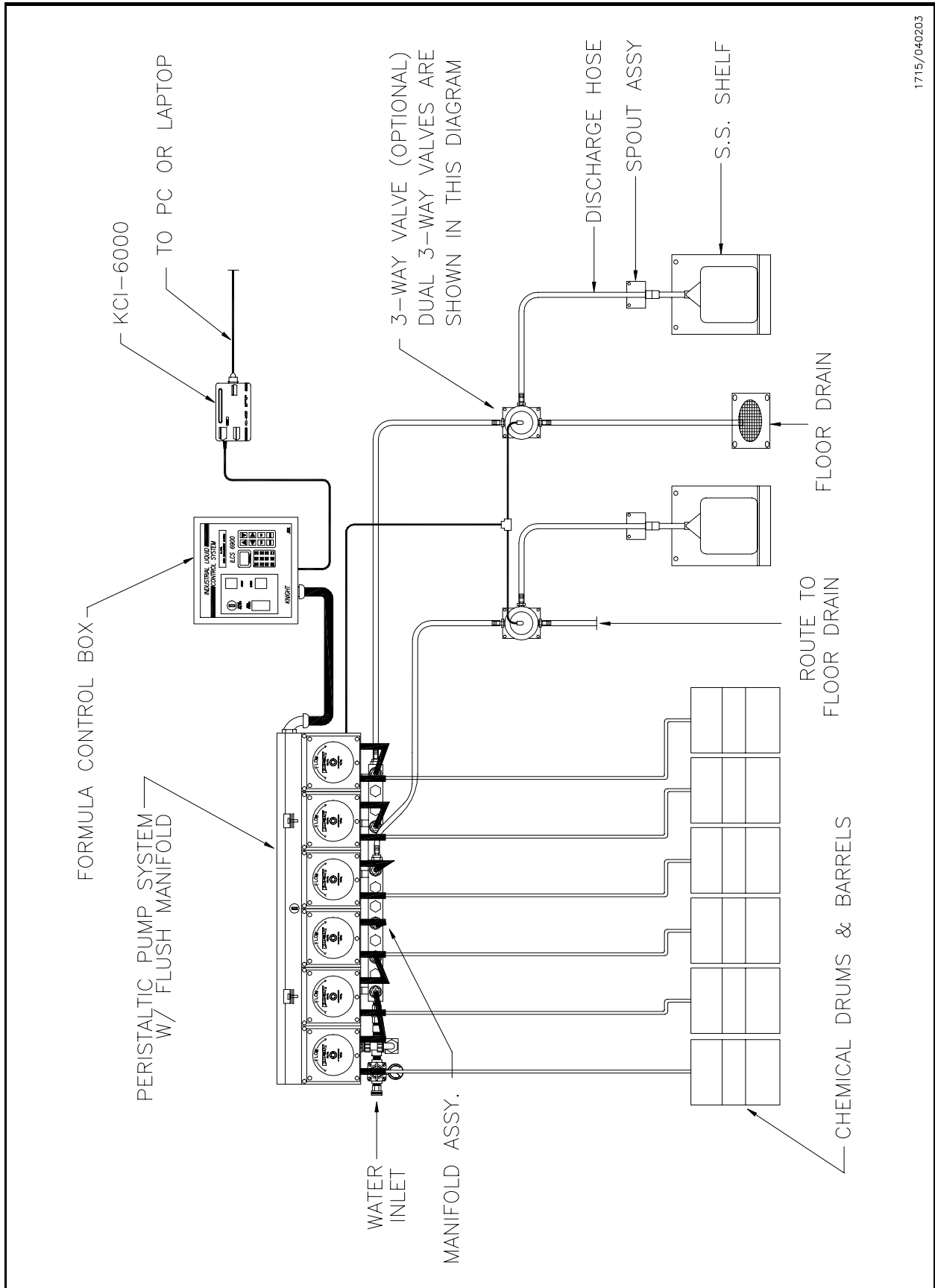

1715/040203

WIRING DIAGRAM — TYPICAL SYSTEM

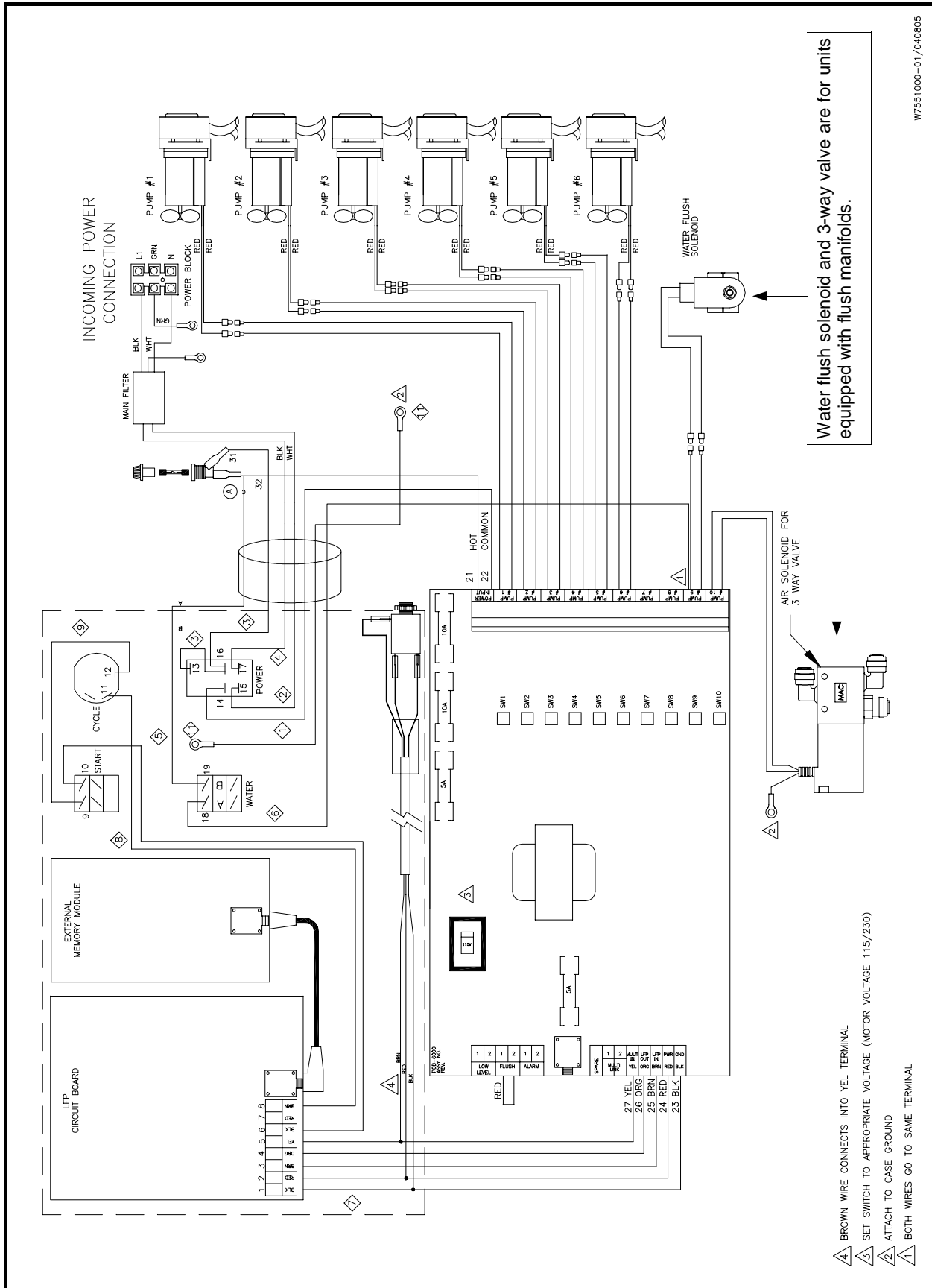

W7551000-01/040605

MANIFOLD COMPONENTS

P/N	DESCRIPTION	QTY	P/N	DESCRIPTION	QTY
0200115	BRASS, CLOSE NIPPLE, #112A-B, 1/4	1	2300778	WASHER, STAR, S.S. #8, EXTERNAL	2
0200147	BRASS NIPPLE, CLOSE 1/2	3	2300812	WASHER, SCREEN (WATER INPUT)	1
0200193	FITTING, REDUCER, PVC, 1 MPT X 1/2 FPT, SCH 80	4	7020150	CLAMP, HOSE, S.S. 1/2, SL-50	6
0200315	FITTING, ADAPTOR, KYNAR, 1/2 MPT X 1/2 BARB	6	7028550	TUBE, T-86E, 1/2IN. ID X 3.25IN.	1
0200906	BRACKET SET W/10-32PEM, NUTS, RIGHT ANGLE	2	7028551	TUBE, T-86E, 1/2IN. ID X 5.0 IN.	2
0300209	FITTING, ADAPTER, BRASS, 1/2IN. FPT X 3/4IN. FGHT	1	7028552	TUBE, T-86E, 1/2IN. ID X 7.75 IN.	1
0300366	CHECK VALVE, MULTI-FLOW, 1/2FNPT X 1/2FNPT	8	7407105	PRES. REGULATOR, 1-25PSI, FOR USE W/PRES. GAUGE	1
0800308	HOSE, BRAIDED, PVC, 1/2ID X 3/4OD X 6 IN	1	7407106	PRESSURE GAUGE, FOR, CHEM-FLUSH MANIFOLD	1
0800389	HOSE, BRAIDED, PVC, 1/2ID X 3/4OD X 19 IN	2	7640347	BRACKET, SOL. SUPPORT, I.L.C.S.	1
1304500	MANIFOLD, 4 PORT, PP, 1/2NPT THREADED PORTS	1	7640348	BRACKET, SOL. MOUNTING, I.L.C.S.	1
1308500	MANIFOLD, 8 PORT, PP, 1/2NPT THREADED PORTS	1	9501367	BRASS, ELL, 1/4 FPT X 1/4 FPT	1
1400470	NIPPLE, 1/2IN. NPT, SCH80 (CLOSE NIPPLE)	8	9600510	FITTING, ST. ELL, BRASS, 1/2MNPTXFNPT, EXTRUDED	2
1600351	PLUG, 1/2MNPT, POLY	6	9600531	FITTING, TEE, BRASS, 1/2 NPT	1
1600384	FITTING, WYE, ACETAL, 1/2 IN	1	9600549	BRASS NIPPLE, 1/2NPT, 1 1/2IN. LENGTH	1
1600693	FITTING, KYNAR, ELL, 1/2BARB X 1/2BARB	4	9600551	SOLENOID VALVE SKINNER, 110/50 OR 120/60	1
1600724	FITTING, ELL, KYNAR, 1/2MNPT X 1/2BARB	4	9600788	1/2 IN FLEX 90 DEGREE, ELBOW CONNECTOR LIQ.	1
1900512	SCREW, PAN HEAD, #10-24 X3/8, PHILLIPS	2	9600789	CONDUIT, 1/2IN CARLON, LIQUIDTITE/NON-METALLC	.17 (ft)
1900613	SCREW, PAN HEAD, S.S., #8-32 X 3/8, PHILLIPS	2	9600790	1/2 IN STRAIGHT FLEX, CONNECTOR LIQUID	1
2000757-1	TIE WRAP, 8 IN LONG	8			

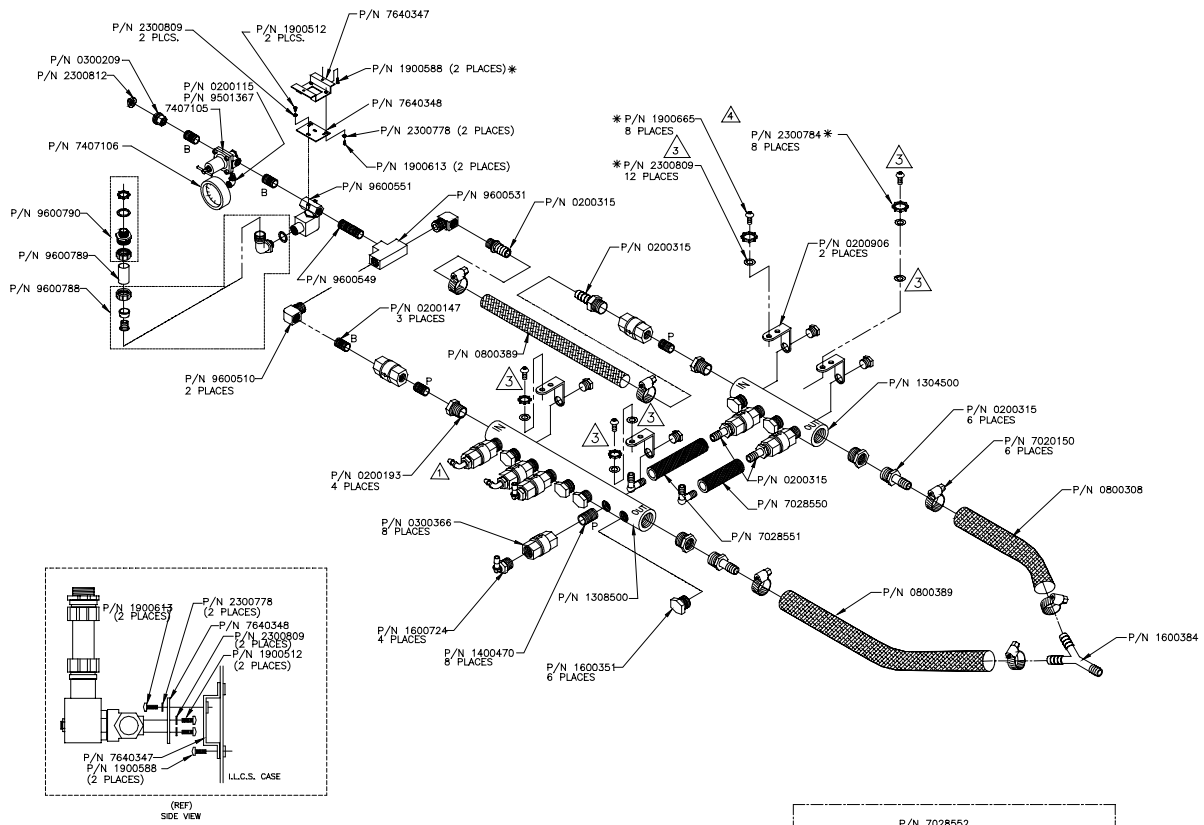

- 4 USE SOFT PIPE/JOINT SEALANT AT ALL THREADED CONNECTION POINTS.
- ⊠ ONE WASHER WILL BE INSTALLED BETWEEN CASE AND BRACKET, ONE SCREW AND ONE WASHER WILL BE INSTALLED FROM INSIDE THE CASE.
(B=BRASS, P=PVC) FOR NIPPLES
- ⊠ LOCATION OF CHECKVALVES ARE OPTIONAL

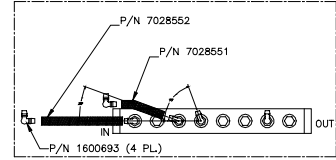

SPOUT ASSEMBLY DIAGRAM

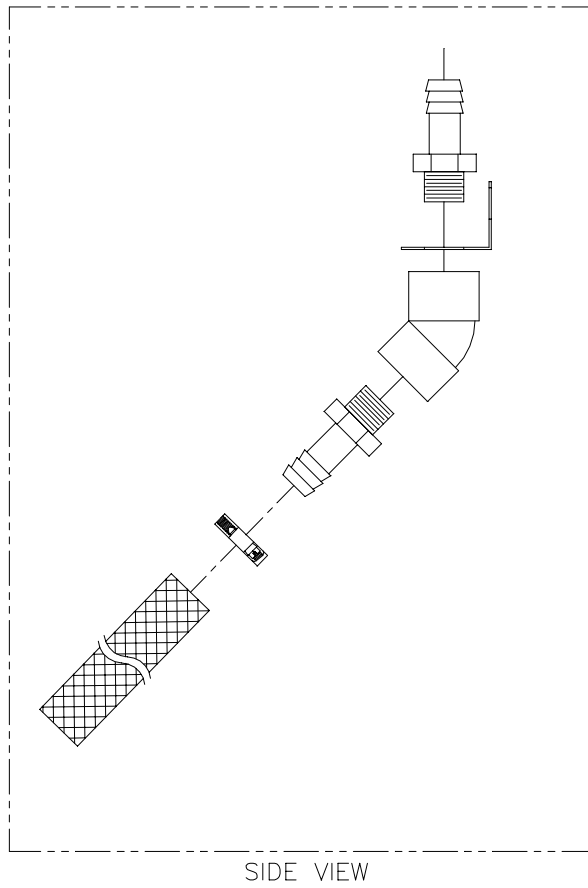
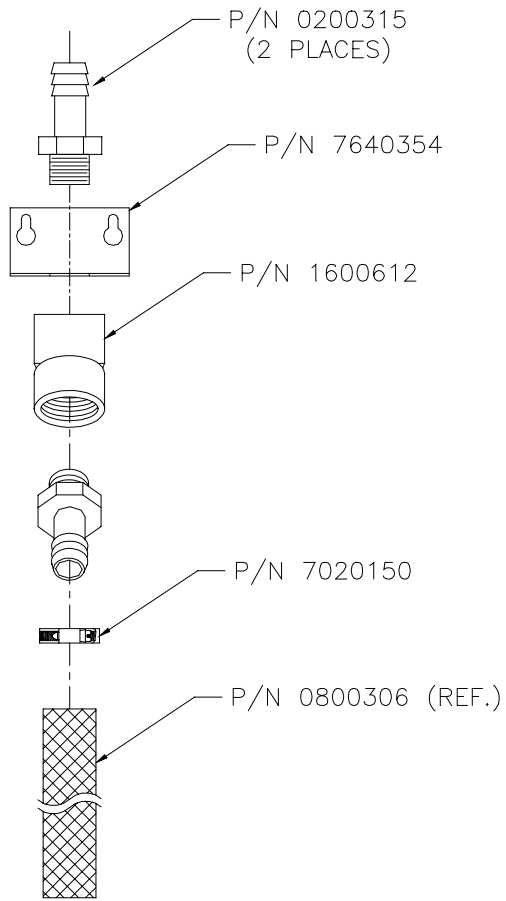

2200092/111902

DISCLAIMER

Knight LLC does not accept responsibility for the mishandling, misuse, or non-performance of the described items when used for purposes other than those specified in the instructions. For hazardous materials information consult label, MSDS, or Knight LLC. Knight products are not for use in potentially explosive environments. Any use of our equipment in such an environment is at the risk of the user, Knight does not accept any liability in such circumstances.

WARRANTY

All Knight controls and pump systems are warranted against defects in material and workmanship for a period of ONE year. All electronic control boards have a TWO year warranty. Warranty applies only to the replacement or repair of such parts when returned to factory with a Knight Return Authorization (KRA) number, freight prepaid, and found to be defective upon factory authorized inspection. Bearings and pump seals or rubber and synthetic rubber parts such as "O" rings, diaphragms, squeeze tubing, and gaskets are considered expendable and are not covered under warranty. Warranty does not cover liability resulting from performance of this equipment nor the labor to replace this equipment. Product abuse or misuse voids warranty.

KNIGHT LLC, A Unit of IDEX Corporation

World Headquarters
20531 Crescent Bay Drive
Lake Forest, CA 92630
Tel: 949.595.4800
Fax: 949.595.4801
www.knightequip.com

USA Toll Free
Tel: 800.854.3764
Fax: 800.752.9518
Canada
Tel: 905.542.2333
Fax: 905.542.1536

Australia
Tel: 61.2.9725.2588
Fax: 61.2.9725.2025
UK
Tel: 44.1293.615.570
Fax: 44.1293.615.585

North Europe
Tel: 31.53.428.5800
Fax: 31.53.428.5809
South Europe
Tel: 34.93.487.1015
Fax: 34.93.215.2019

North Asia Pacific
Tel: 82.2.3481.6683
Fax: 82.2.3482.5742
Southeast Asia
Tel: 65.9170.0984
Fax: 65.6489.6723