



ILCS WinReporter Version 2.1 Instruction Manual

TABLE OF CONTENTS

Getting Started 3

Setting Up The Network 4

Network Diagram..... 5

Configuration Settings 6

File Commands Screen 7

Location Settings 8

Logging On 10

Programming 11

Working With Files..... 18

Printing Reports..... 20

Spreadsheet Functions..... 22

Modem Setup 24

Other Features 26

Warranty Information 28

Knight Locations 28

GETTING STARTED

Thank you for your purchase of Knight Reporter software. This comprehensive and user-friendly program will make your PC a valuable tool for printing reports and programming ILCS dispensing systems. For added versatility, the software can be used on-site or off-site (via modem), and will run on either a standard desktop PC or laptop.

Before attempting to install this program, make sure there is an open USB port or serial com port on your computer to communicate with the KCI-6000 Computer Interface (or RM-6000 Reporter Module if used).

- The PC must have a default printer driver installed to print, view, or save reports to the PC.
- You must have at least 10 megabytes of space on your hard drive for a complete installation.
- Reporter Software runs best with at least 64 megabytes of memory.
- Reporter Software is compatible with Windows versions 98, Me, NT4, 2000, and XP.

Installing Reporter Software

- (1) Turn on computer and monitor.
- (2) Start Windows.
- (3) Turn off all other Windows applications and network connections.
- (4) Insert Reporter CD into the appropriate drive on your computer.
- (5) If the installation utility does not start automatically (after a short time) click on the Windows Start button, then click on Run.
- (6) In the "Open" box, type x:setup then click OK (where x represents the drive letter of your CD-ROM).
- (7) As Reporter Software is installed, follow the instructions on your screen.

Uninstalling Reporter Software

There is an uninstall utility that is put onto your PC when you run Reporter software. Should it become necessary to uninstall Reporter software, the following steps will remove the program and return your PC to its original state (before Reporter was installed).

- (1) Go to Windows Control Panel.
- (2) Double-click on Add/Remove Programs.
- (3) Select WinReporter from the list, then click the Add/Remove button.
- (4) Follow the prompts on your screen to un-install Reporter Software.

SETTING UP THE NETWORK

To run Reporter Software on-line with a dispenser requires the use of a KCI-6000 or RM-6000I interface module (detailed below). A USB cable is provided with the software package and should be applicable for most applications. See page 6 for details. A driver disk is also included to setup your PC for use with the USB connection on the KCI-6000 module.

Note: If using the optional hardware key cable, you must connect it to a working serial com port on your computer. The program automatically detects the serial com port on your PC that the cable is connected to. If your system has difficulty locating the hardware cable, contact Knight for assistance.

Connect the PC to the KCI-6000 (or RM-6000I) using the appropriate cable. See wiring diagram to the right for details. Apply power to the KCI-6000 or RM-6000I by connecting the network cable from the dispenser network to the dispenser interface port. By default, the KCI-6000 is the selected computer interface device. If an RM-6000I is used, you must choose it as the computer interface device in the com port configuration screen (details on page 6).

Note: For RM-6000I applications (only) a 12 VDC booster transformer must be installed if the network cable length is 100 feet or greater. See wiring diagram to the right for details. The booster transformer will increase the data signal strength to assure consistent communication with the ILCS dispensing system. The booster is not required for KCI-6000 applications.

KCI-6000 Computer Interface

- By default, the KCI-6000 module is the selected computer interface device in the com port configuration.
- The KCI-6000 allows for faster printing and data transfers.
- The KCI-6000 does not allow storage of dispenser files.
- The KCI-6000 allows WinReporter to communicate with any version of ILCS dispenser (backwards compatible).
- A standard USB cable can be used to connect directly to the KCI-6000 (models built starting June, 2005).

RM-6000I Module

- To use an RM-6000I module, you must choose it as the computer interface device in the com port configuration screen (details on page 6).
- For remote operation offsite, it is not necessary to connect the RM-6000I Reporter Module to your PC unless files are to be downloaded to it. If remote files are to be created, or you wish to edit existing files or print saved files. It is not necessary to connect the hardware cable to your PC.
- The RM-6000I Reporter Module is a passive interface when installed on site. There is no real need to transfer files to or from the RM module in a permanent installation such as in your customers PC.
- For users that wish to use the RM-6000I Reporter Module to transfer files and reports from the field to an office PC for report printing and archiving, use Reporter Software to move and delete files in the RM file directory.
- The RM-6000I can only communicate with older ILCS systems (version 1.xx).
- Requires the use of the hardware key cable only (cannot connect directly with a standard USB cable).

Network Diagram

(not to scale)

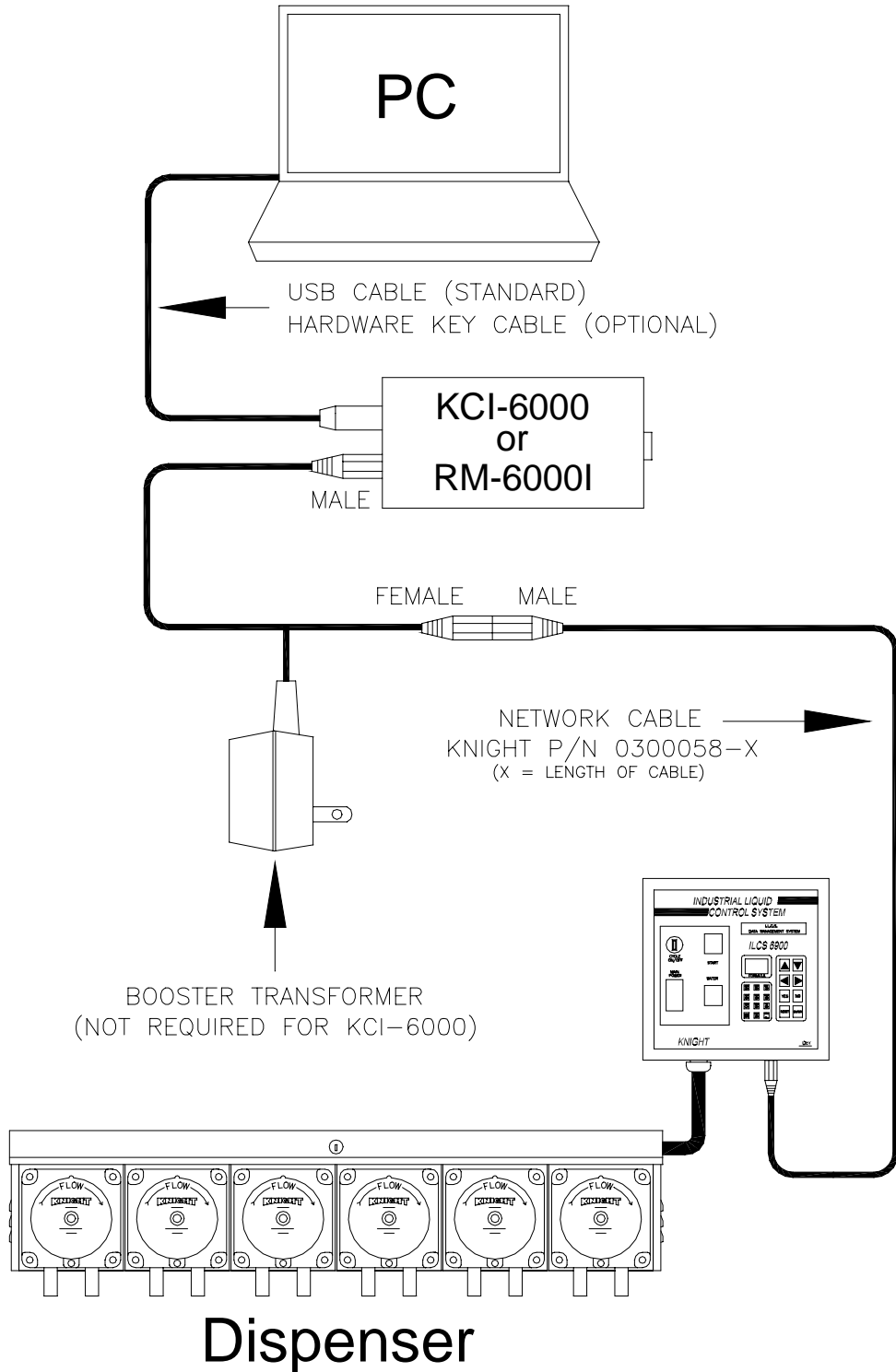

ILCS-REPORTER-DIAG/062105

CONFIGURATION SETTINGS

When to use this screen

The configuration screen is only required if either (or both) of the conditions listed below apply. For all other applications, no changes are necessary.

- If a USB port is used instead of a serial com port
- If RM-6000I will be used instead of the KCI-6000

Using a USB port

The standard PC connection is for use with a USB port. There are two options for setting up your computer:

- The latest version of the Knight KCI-6000 has USB interface capability. All you will need to do is install the drivers from the CD provided with the KCI-6000. An instruction sheet is also included with the KCI-6000 to guide you through proper setup.
- An adapter kit (available from your PC vendor) will allow your USB port to function as a standard com port. Install the kit according to the instructions that come with it. Be sure to find out which com port number the USB port will function as, since this port number will be assigned in the configuration screen below. After you have successfully converted your USB port to a com port, you will then need to plug the hardware key cable into the USB adapter.

Changing the settings

- (1) Click Setup (from the pull-down menus at the top) then Com Port. The display below will appear.
- (2) If you are using a USB Port: First de-select the Auto Detect Cable checkbox. Then choose the com port number that corresponds to the USB port's assigned number (choosing a baud rate is not necessary).
- (3) If you are using an RM-6000I: Choose RM-6000 as the Computer Interface device.
- (4) When finished setting up the configuration, click the OK button.

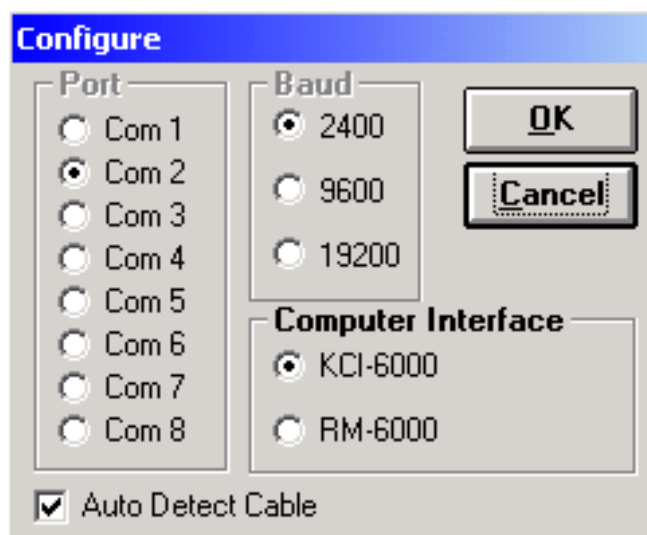

FILE COMMANDS SCREEN

The File Commands screen is where all of the programming is done. The display also shows the ID number, descriptive name, and external memory status of the ILCS system when logged on.

- Location Settings – Takes you to the Customer Locations screen (detailed on page 8).
- Logon – Takes you to the logon screen (detailed on page 10).
- Receive Dispenser File – Downloads information from the system you're logged onto (detailed on page 11).
- Send Dispenser File – Uploads the selected HEX file to the system you're logged onto (detailed on page 11).
- Logoff/Reset – Disconnects you from the dispenser network. Also makes the RM File Directory button available if not connected to a dispenser network (when using an RM-6000I).
- Reports – Takes you to the report screen (detailed on page 20).
- New Setup – Used for creating a new HEX file (detailed on page 11).
- Save Setup – Used as a “quick save” feature when working with HEX files (detailed on page 11).
- RM File Directory – Takes you to the file directory screen for the RM-6000I module (detailed on page 19).
- Print Icon – Allows you to print a HEX file. Choose the file from the Setup File window, then click the icon.
- Module Icon – Shows which PC interface device you are using (KCI or RM). This icon will flash green when there is communication activity taking place.

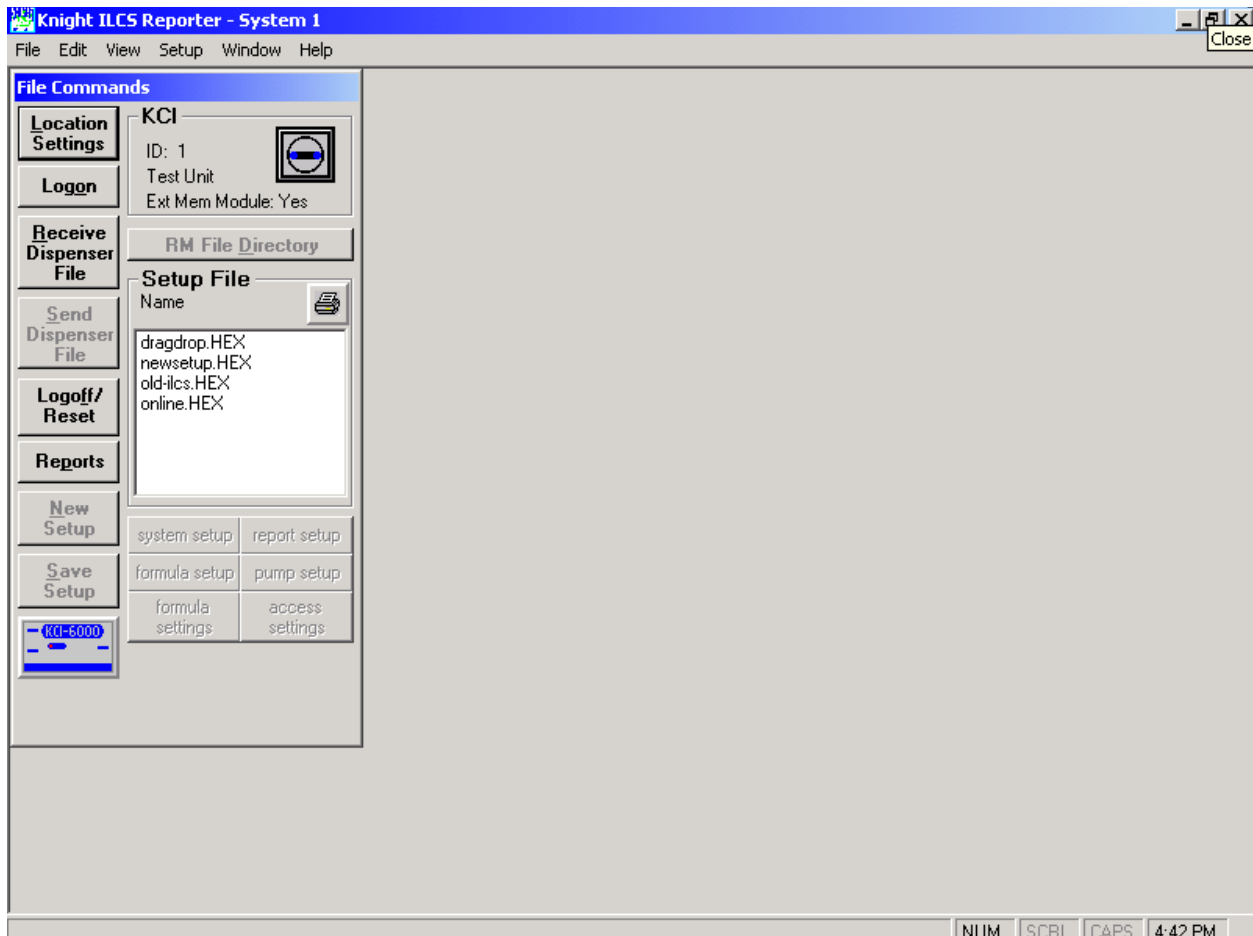

LOCATION SETTINGS

The location settings contain the ID number of each ILCS system in the network (if more than one) as well as allowing you to enter descriptive names for each system. Each location setting that is created will have its own “sub-folder” on the PC for storing setup and report files.

Multiple customer locations can be setup and saved. For laptop users that will run Reporter Software at various locations, saved settings can be selected from the Location Settings box when going from one account to another. Changing locations will change the number of ILCS systems listed in the Report Parameters (print functions). This is important anytime you print reports from the entire network or individually.

Creating a new location

- (1) Click on Location Settings and you will see the screen to the upper right.
- (2) Click New, then type the name you wish to give the account and click OK. You will then see the screen to the lower right.
- (3) Type in the system ID# in the first column, then add a descriptive name for the system.
- (4) When finished entering data for all systems at the location, click Save to store the information.

Changing locations

- (1) Click on Location Settings and you will see the screen to the upper right.
- (2) Click on the desired choice from the Available Customer Locations, then click OK. You will then see the screen to the lower right.
- (3) Click on Close if all information is correct . If you wish to modify the location setup, make any necessary changes, then click Save to store the information.

Deleting a location

- (1) Click on Location Settings and you will see the screen to the upper right.
- (2) Click on the desired choice from the Available Customer Locations, then click delete.
- (3) The chosen customer location will be deleted.

Copying and deleting files

You can copy setup (HEX) files from one location to another using the Customer Locations display. This is a helpful feature when you have accounts with similar ILCS systems, and wish to use a particular file from one account as a “template” to quickly setup a HEX file for another. You can also delete files that are not needed to free up space on your PC.

- (1) Click on Location Settings and you will see the screen to the upper right.
- (2) Click on the desired choice from the Available Customer Locations and the HEX files for that account will appear in the small window on the lower left of the display.
- (3) Click another choice from the Available Customer Locations and the HEX files for that account will appear in the small window on the lower right of the display.
- (4) Click on the desired file, then click either Copy or Delete. If you are copying a file, notice that arrows on the copy buttons show which “direction” the file will be copied. If you wish to start over, click the Clear List button.

LOGGING ON

Logging on is typically done “locally” using the on-site PC that is connected to the ILCS systems, however you can logon from a remote PC via modem. Logging on is not required when working with files, such as creating a new HEX file, or viewing/printing report files that are saved on your PC. You must logon to do any of the following:

- Creating new reports, whether directly to a printer or choosing the “print to file” option.
- Changing ILCS system settings on-line.
- Uploading or downloading HEX file information.

On-site (locally)

- (1) Click on the Log-On button.
- (2) Enter the dispenser ID and access code.
- (3) Click Connect. During the log-on process, the module icon will flash green.

From a remote PC (via modem)

Before attempting to logon via modem, make sure that the PC connected to the ILCS system and the remote PC are properly setup for modem operation (detailed on pages 24 and 25). Also check that the Modem Interface software is running properly and waiting for a call.

- (1) Click on the Log-On button.
- (2) Enter the dispenser ID and access code.
- (3) Click VIA Modem, then Connect and you will see the screen to the right.
- (4) In the RM-6000 Module Code box, enter the access code that was setup in the modem interface software of the on-site PC.
- (5) Enter the phone number. If you have several locations that you remotely dial into, you can setup the phone numbers using the Account Settings button to the right.
- (6) Click Dial. During the log-on process, the module icon will flash green.

NOTE: If you get a message telling you that the network is busy, another user is currently logged on.

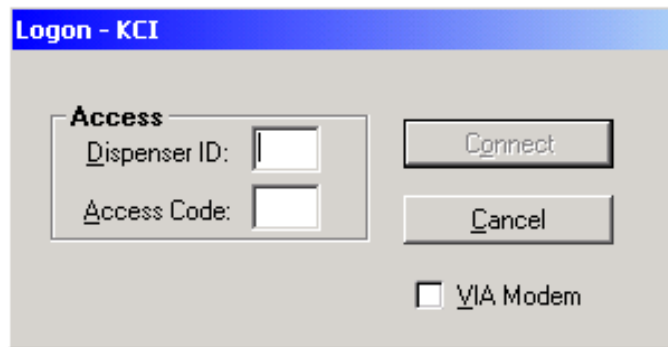

Logon - KCI

Access

Dispenser ID:

Access Code:

VIA Modem

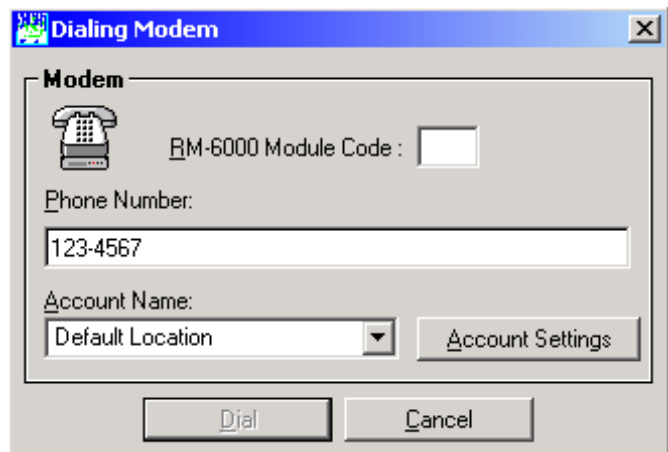

Dialing Modem

Modem

RM-6000 Module Code :

Phone Number:

Account Name:

PROGRAMMING

All system programming can be done on-line or off-line. Programming off-line is also known as setting up a HEX file. This feature allows you to create setup information without even being connected to the ILCS system. For example, if you have a laptop PC, you can program HEX files in your office, then take your PC on-site and upload the settings as part of your installation.

In some of the programming functions throughout this manual, you will notice differences that are mentioned between newer ILCS systems (version 2.00 and higher) and older systems (version 1.xx). If you are not sure what version of ILCS you have, simply go to the control panel and press ENTER, then NO. The version number will appear in the lower right corner of the display with the letter "V" next to it. Press RESET when you are finished checking the version number.

Notes: For metric file downloads, all formula volume settings must be programmed in liters. Reporter will not convert milliliters to liters.

Programming a system on-line

- (1) Logon to the system.
- (2) If the system is already programmed and you are only making changes, you can skip this step.

If this is a new installation, or you want to completely re-program an existing system, click Setup then Clear Settings and choose all boxes to clear the dispenser memory. After memory clearing is complete, click Setup then Set Clock, and make any time or date adjustments as needed.

- (3) Click on Receive Dispenser File to "download" the setup information onto your PC. The module icon will flash and the progress of the download will be displayed by a colored bar.
- (4) When the download is complete, you can proceed with the programming menus that are detailed on the following pages.
- (5) When finished programming you will be prompted if you wish to save the information as a file when you logoff. If you want to save the information as a HEX file, type in a file name and click Yes. This is an optional step because all changes to the system are updated in real time during on-line programming.

Programming a system off-line

- (1) Click the New Setup button.
- (2) When prompted, choose the type of system (version 1.xx or version 2.00 and higher).
- (3) Proceed with the programming menus that are detailed on the following pages.
- (4) When finished programming, click the Save Setup button and you can enter the name of the HEX file you wish to create. You can also click Save Setup if you are working with an existing dispenser file.

Uploading a HEX file

- (1) Logon to the dispenser.
- (2) If this is a new installation, or you want to completely re-program an existing dispenser, click Setup then Clear Settings and choose all boxes to clear the dispenser memory. After memory clearing is complete, click Setup then Set Clock, and make any time or date adjustments as needed.
- (3) From the displayed list of HEX files, click the one you wish to upload, then click Send Dispenser File. You can also "drag-n-drop" the HEX file onto the pump icon.
- (4) The module icon will flash and the progress of the upload will be displayed by a colored bar.

System Setup

There are only a few minor differences between programming a system on-line and programming off-line (working with a HEX file). For example, the Main Access Code, User Access Code and I.D. can not be saved in a HEX file. These settings can only be changed when on-line with the system or at the systems control panel (in the programming menus). Date/time information is kept in the system memory, and is not stored in a HEX file.

- Access Codes — Click and enter Main Access Code (up to 3 digits). Main Access Code enables all functions of Reporter. Click and Enter User Access Code. User Access Code allows your customer to print /view reports.
- ID Number — Select an appropriate ID number for the system. If there is only one system at the location, then there is no need to change the ID number. If there is more than one system on a "multilink network", then all systems must have a unique ID to communicate. If the system ID number is changed, then the external memory module must also be changed (this only applies to version 2.00 and higher systems). See page 26 for details on setting the external memory module ID.
- Operating Zone — This selection allows you to select whether or not you wish to establish "on" and "off" times of operation for the system. The default start and end times allow the system to dispense chemical at any time, day or night. When the system is out of the operating zone the main display screen will show "OUT OF OPERATING ZONE". Any attempt to dispense chemical outside of the operating zone will be prohibited.
- Unit of Measure — Select U.S., Metric or Imperial. For programming formula volume settings, GALLONS or MILS are not selectable. The default units are ounces (US and Imperial) or liters (Metric) only.
- Flush Settings — If using a flush manifold, Flush Pump time sets the time the flush solenoid will operate after the pumps have finished. Flush Error Delay is for flush applications where a flow switch is used to verify actual water flow (if set to 00, this feature is turned "off", and the flow switch input will not be checked). To Drain After is when the optional 3-way valve will divert flow from the normal dispense position to the drain position.
- Simultaneous Pump — This setting chooses if the system will run all pumps simultaneously in the chosen formula. If this setting is off, then pumps will run sequentially from lowest number to highest during the formula.
- Number of Users — This setting allows you to pick the number of users and the formula access settings (batch allowance) associated with each one.

System Setup

Unit of Measure
 U.S.
 Metric
 Imperial

Operating Zone
Start Time
Stop Time

Flush Settings
Flush pump time (sec)
To Drain After (sec)
Flush Error Delay(sec)

Number of Users
 400 En/Dis Form Uses
 50 0-99 Uses

ID Number

Simultaneous Pump
 Off
 On

Access Codes
Main User

Report Setup

- Installation — Double click and enter dispenser installation dates using same date format; __/__/__.
- Shift Start Times — Double click and enter shift times in military time (24-hour clock).
- Report Name — This is the name that appears as a heading on printed reports.

Report Setup

Installation

Dispenser 00/00/00

Shift Start Times

Shift 1 06:00

Shift 2 11:00

Shift 3 17:00

Report Name

Cancel OK

Formula Setup

- ❑ **Formula Name** — Allows you to set individual formula name descriptions for the desired dispenser. Use tab key to move from cell to cell. Enter maximum of 19 characters to name a formula. Giving each formula a descriptive name makes the system more user-friendly.

Version 2.00 and higher systems have 99 available formulas.

Version 1.xx systems have 50 available formulas.

The screenshot shows a dialog box titled "Formula Setup" with a blue header. Below the header is a table with two columns: "#", which is highlighted in blue, and "Name", which is highlighted in light green. The table contains 20 rows, numbered 1 through 20, each with the name "FORMULA 01" through "FORMULA 20" respectively. To the right of the table is a vertical scrollbar with up and down arrow buttons. At the bottom of the dialog box is a button labeled "Close".

#	Name
1	FORMULA 01
2	FORMULA 02
3	FORMULA 03
4	FORMULA 04
5	FORMULA 05
6	FORMULA 06
7	FORMULA 07
8	FORMULA 08
9	FORMULA 09
10	FORMULA 10
11	FORMULA 11
12	FORMULA 12
13	FORMULA 13
14	FORMULA 14
15	FORMULA 15
16	FORMULA 16
17	FORMULA 17
18	FORMULA 18
19	FORMULA 19
20	FORMULA 20

Pump Setup

Set from 1 - 9 individual Pump Names by pressing tab or enter keys to move from cell to cell. Enter new descriptions. Product Names limited to 7 characters (including spaces). Press tab or enter (cursor moves right one cell) to set pump flow rates.

To change flow rates unit of measure, move cursor to cell and click to edit Flow Rate unit of measure. While flow rates can be entered manually, the pumps should be calibrated to achieve the most accurate flow rate data.

The calibrate function cannot be performed off-line (i.e. working on a HEX file). You will need a container with volume markings, such as a beaker or graduated cylinder. To calibrate, select the desired pump from Pump Names view (click on it), then click on Setup, and select Auto Calibration. Click Start Pump and let the pump run for about 60 seconds, then click Stop Pump. You will be prompted for the amount pumped. Type in the volume, select unit of measure, then click OK. The program will then calculate the actual flow rate.

Tab over to set Product Costs per unit. Range is _ _ _ . _ _ only. Do not enter currency symbol. Tab over to Tubes Changed and Tubes Lubed Date. Double click on cell and set dates using calendar or type in manually. Copy and paste functions can be used to save time.

Minimum programmable flow rates:

- US = 3 oz/min or .03 gal/min.
- Metric = 60 ml/min or .06 lit/min.
- Imp = 2.2 oz/min or .02 gal/min.

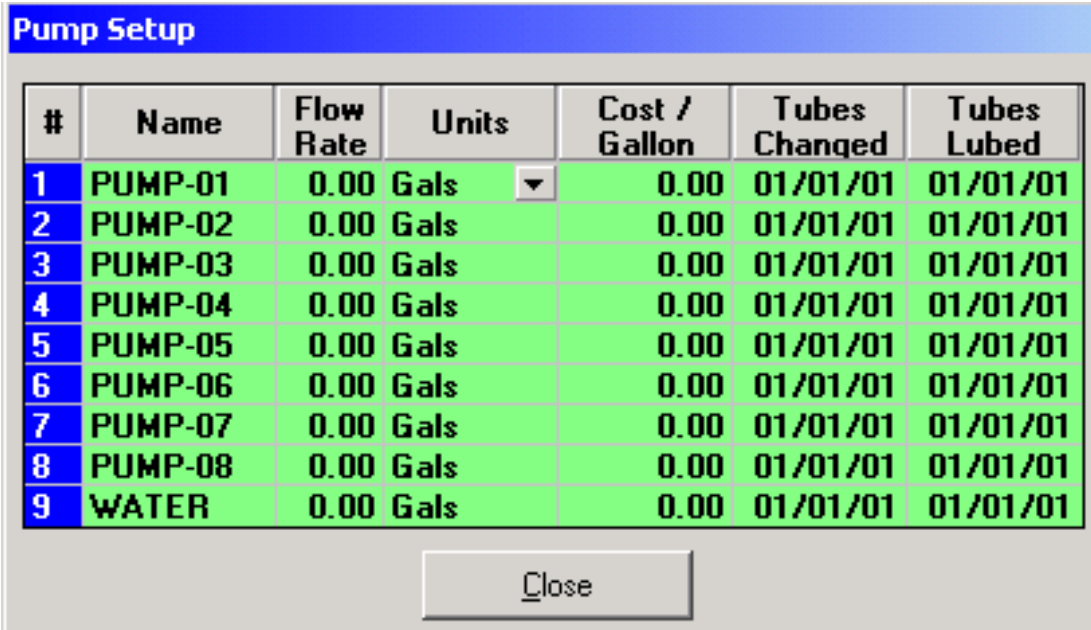

#	Name	Flow Rate	Units	Cost / Gallon	Tubes Changed	Tubes Lubed
1	PUMP-01	0.00	Gals	0.00	01/01/01	01/01/01
2	PUMP-02	0.00	Gals	0.00	01/01/01	01/01/01
3	PUMP-03	0.00	Gals	0.00	01/01/01	01/01/01
4	PUMP-04	0.00	Gals	0.00	01/01/01	01/01/01
5	PUMP-05	0.00	Gals	0.00	01/01/01	01/01/01
6	PUMP-06	0.00	Gals	0.00	01/01/01	01/01/01
7	PUMP-07	0.00	Gals	0.00	01/01/01	01/01/01
8	PUMP-08	0.00	Gals	0.00	01/01/01	01/01/01
9	WATER	0.00	Gals	0.00	01/01/01	01/01/01

Close

Formula Settings

This programming grid allows you to set the chemical volumes for the required pumps in each formula. To move through the Formula Volume Settings grid, simply use the arrow, tab or enter keys. The active cell is highlighted with a dark border. For U.S. and Imperial units of measure, the maximum programmable pump volume is 9999.9 ozs. For Metric units, the maximum programmable volume is 99.99 liters.

- US and Imperial volumes must be programmed in ounces.
- Metric pump volumes must be programmed in liters.

The light blue and white portions of the grid indicates the cells that can be programmed. The dark blue area can not be changed from this grid. Simply enter the pump volumes required for each formula, and advance to the next cell by pressing arrow, enter and tab keys. If you are programming an ILCS system on-line, new settings are updated on the dispenser as soon as you change cells.

Remember to save settings after you edit a HEX file on the PC and download the revised dispenser file if changes are made on-line.

#	Formula Name	Pump 1 PUMP-01 Volume	Pump 2 PUMP-02 Volume	Pump 3 PUMP-03 Volume	Pump 4 PUMP-04 Volume	Pump 5 PUMP-05 Volume	Pump 6 PUMP-06 Volume	Pump 7 PUMP-07 Volume	Pump PUMP-08 Volum
1	FORMULA 01	0.0	0.0	0.0	0.0	0.0	0.0	0.0	
2	FORMULA 02	0.0	0.0	0.0	0.0	0.0	0.0	0.0	
3	FORMULA 03	0.0	0.0	0.0	0.0	0.0	0.0	0.0	
4	FORMULA 04	0.0	0.0	0.0	0.0	0.0	0.0	0.0	
5	FORMULA 05	0.0	0.0	0.0	0.0	0.0	0.0	0.0	
6	FORMULA 06	0.0	0.0	0.0	0.0	0.0	0.0	0.0	
7	FORMULA 07	0.0	0.0	0.0	0.0	0.0	0.0	0.0	
8	FORMULA 08	0.0	0.0	0.0	0.0	0.0	0.0	0.0	
9	FORMULA 09	0.0	0.0	0.0	0.0	0.0	0.0	0.0	
10	FORMULA 10	0.0	0.0	0.0	0.0	0.0	0.0	0.0	
11	FORMULA 11	0.0	0.0	0.0	0.0	0.0	0.0	0.0	
12	FORMULA 12	0.0	0.0	0.0	0.0	0.0	0.0	0.0	
13	FORMULA 13	0.0	0.0	0.0	0.0	0.0	0.0	0.0	
14	FORMULA 14	0.0	0.0	0.0	0.0	0.0	0.0	0.0	
15	FORMULA 15	0.0	0.0	0.0	0.0	0.0	0.0	0.0	
16	FORMULA 16	0.0	0.0	0.0	0.0	0.0	0.0	0.0	
17	FORMULA 17	0.0	0.0	0.0	0.0	0.0	0.0	0.0	
18	FORMULA 18	0.0	0.0	0.0	0.0	0.0	0.0	0.0	
19	FORMULA 19	0.0	0.0	0.0	0.0	0.0	0.0	0.0	
20	FORMULA 20	0.0	0.0	0.0	0.0	0.0	0.0	0.0	
21	FORMULA 21	0.0	0.0	0.0	0.0	0.0	0.0	0.0	
22	FORMULA 22	0.0	0.0	0.0	0.0	0.0	0.0	0.0	
23	FORMULA 23	0.0	0.0	0.0	0.0	0.0	0.0	0.0	
24	FORMULA 24	0.0	0.0	0.0	0.0	0.0	0.0	0.0	
25	FORMULA 25	0.0	0.0	0.0	0.0	0.0	0.0	0.0	
26	FORMULA 26	0.0	0.0	0.0	0.0	0.0	0.0	0.0	
27	FORMULA 27	0.0	0.0	0.0	0.0	0.0	0.0	0.0	
28	FORMULA 28	0.0	0.0	0.0	0.0	0.0	0.0	0.0	

Formula Access Settings

This screen allows you to setup user names, user passwords, and which formulas each user will have access to. See the details below for the differences between newer and older versions of ILCS.

- Version 1.xx: Total number of users is 50. Each formula is set as a number of batches allowed (99 max) for the selected user. The ILCS system keeps a tally of the number of batches that the user has dispensed on each formula. When they have used up their allowance, or if the formula access is set to 0, they will see the message "ACCESS RESTRICTED" if they attempt to dispense a batch. The ILCS system resets the tally at the beginning of each shift. If shift times are not programmed, then the tally is reset at the beginning of the next day.
- Version 2.00: Total number of users is 400. Each formula is set as either enabled (1) or disabled (0) for the selected user. For each formula that the user is allowed (set to 1) they will have unlimited access and can dispense any number of batches they need. For each formula that the user is not allowed (set to 0) they will see the message "ACCESS RESTRICTED" if they attempt to dispense a batch.
- Version 2.1: Allows you to choose the number of users (50 or 400) in the System Setup screen. The formula access settings described above will then be applicable based on the number of users that you chose.

50 User Format

The screenshot shows a window titled "Knight ILCS Reporter - [Access Settings]" with a menu bar (File, Edit, View, Setup, Window, Help) and a toolbar with a "Close" button. The main area contains a table with the following structure:

		Formula Access Range 0-99													
USER #	PASSWORD	USER NAME	F 1	F 2	F 3	F 4	F 5	F 6	F 7	F 8	F 9	F 10	F 11	F 12	F
1		USERID NAME 001	99	99	99	99	99	99	99	99	99	99	99	99	99
2		USERID NAME 002	99	99	99	99	99	99	99	99	99	99	99	99	99
3		USERID NAME 003	99	99	99	99	99	99	99	99	99	99	99	99	99
4		USERID NAME 004	99	99	99	99	99	99	99	99	99	99	99	99	99
5		USERID NAME 005	99	99	99	99	99	99	99	99	99	99	99	99	99
6		USERID NAME 006	99	99	99	99	99	99	99	99	99	99	99	99	99
7		USERID NAME 007	99	99	99	99	99	99	99	99	99	99	99	99	99
8		USERID NAME 008	99	99	99	99	99	99	99	99	99	99	99	99	99
9		USERID NAME 009	99	99	99	99	99	99	99	99	99	99	99	99	99
10		USERID NAME 010	99	99	99	99	99	99	99	99	99	99	99	99	99
11		USERID NAME 011	99	99	99	99	99	99	99	99	99	99	99	99	99
12		USERID NAME 012	99	99	99	99	99	99	99	99	99	99	99	99	99
13		USERID NAME 013	99	99	99	99	99	99	99	99	99	99	99	99	99

400 User Format

The screenshot shows a window titled "Knight ILCS Reporter - [Access Settings]" with a menu bar (File, Edit, View, Setup, Window, Help) and a toolbar with a "Close" button. The main area contains a table with the following structure:

		Formula Access 1=Enabled 0=Disabled													
USER #	PASSWORD	USER NAME	F 1	F 2	F 3	F 4	F 5	F 6	F 7	F 8	F 9	F 10	F 11	F 12	F
1		USERID NAME 001	1	1	1	1	1	1	1	1	1	1	1	1	1
2		USERID NAME 002	1	1	1	1	1	1	1	1	1	1	1	1	1
3		USERID NAME 003	1	1	1	1	1	1	1	1	1	1	1	1	1
4		USERID NAME 004	1	1	1	1	1	1	1	1	1	1	1	1	1
5		USERID NAME 005	1	1	1	1	1	1	1	1	1	1	1	1	1
6		USERID NAME 006	1	1	1	1	1	1	1	1	1	1	1	1	1
7		USERID NAME 007	1	1	1	1	1	1	1	1	1	1	1	1	1
8		USERID NAME 008	1	1	1	1	1	1	1	1	1	1	1	1	1
9		USERID NAME 009	1	1	1	1	1	1	1	1	1	1	1	1	1
10		USERID NAME 010	1	1	1	1	1	1	1	1	1	1	1	1	1
11		USERID NAME 011	1	1	1	1	1	1	1	1	1	1	1	1	1
12		USERID NAME 012	1	1	1	1	1	1	1	1	1	1	1	1	1
13		USERID NAME 013	1	1	1	1	1	1	1	1	1	1	1	1	1

WORKING WITH FILES

- ❑ Saving Setup Program File — After creating a new dispenser setup program while on line or remote, click on Save Setup button, name the file and click OK. Named file will then be saved to hard drive and displayed in the Setup File directory as a .HEX file.
- ❑ Viewing or Editing Setup Program File (.HEX) — Double click the desired file from the Setup File directory. After the program opens the file, it will prompt you to select various programming screens. File is now ready to be viewed or edited.

Note: The name of the open .HEX file will be displayed on the title bar of the Reporter display screen.

- ❑ Transferring Saved Setup Program Files to Dispenser — Log on to desired dispenser. Click on desired .HEX setup file located in Computer file directory, then click Send Dispenser File button. You can also transfer by “dragging” the file (Hand with document must appear) to dispenser pump icon and dropping the file.

Note: Setup files can not be transferred directly from the RM-6000 file directory (if an RM-6000I is used) to the ILCS system using Reporter Software.

- ❑ Deleting Files — To delete files in the Setup File directory, RM-6000 File Directory (if an RM-6000I is used) or the Report directory, click the file to be deleted and press delete key on PC keyboard.
- ❑ HEX Files — These are dispenser setup files that are saved on the PC. HEX files can be transferred to and from a dispenser. The HEX files listed in your Setup File directory can be opened for viewing and editing by double clicking on desired file. Setup files shown in the RM-6000 File Directory (if an RM-6000I is used) must be dragged and dropped to the PC directory before they can be viewed or edited. After changes are made to any HEX file, the program will ask you to save changes and to name/rename the file.
- ❑ To copy saved report files (Setup, Summary, Batch) or HEX files to a floppy disk (or any other type of disk), use Windows Explorer. Find the ILCS WinReporter directory. Open the folder labeled “data”, then open the folder of the specific customer location. All HEX and RPT files listed here and can be copied to disk as needed.
- ❑ RPT Files — These are report files that reside in the computer. A list of RPT files is shown when clicking the Reports button. These files can be viewed by double clicking the desired file.
- ❑ 00/00/00 00:00 (RM-6000 Reporter Module Files) — These files can be Setup, Summary or Cycle Files that were downloaded from an ILCS system to a RM-6000I (if used). Only setup files can be dragged to the PC directory. After they are transferred, they can be viewed, edited and reused.

Note: Prior to completing on-line programming, be sure that correct time and date are set in each dispenser. From the Setup Menu, select Set Clock/Date setting.

RM-6000I Reporter Module File Maintenance

The RM-6000I can be used as a portable memory module for uploading setup files to the ILCS system, or downloading reports for printing later. By programming setup files on a PC off site, files can then be copied to the RM module for transport to the job site. Setup files can be uploaded from the RM into the ILCS system using menu #1 on the control panel (version 1.xx only). Please note: Setup files can only be uploaded from directory #1 on the RM module.

To manage files within the RM-6000I Reporter Module, click the RM File Directory button. If the RM File Directory button is not highlighted, then click on Logoff/Reset first, and after a few seconds click the RM File Directory button when it is highlighted.

- To delete individual files — select the file to be deleted and press Delete key on your PC.
- To delete all files from directories — click the Clear button and select which directories to be cleared.
- To copy files — Files can be copied from directory to directory by using the drag and drop procedure. Select file using left click, hold down mouse while dragging to desired directory and drop (let go of mouse). Wait for file to transfer and screen to refresh.
- To print files — select the file, then click the Print button. Choose any options from the print menu that will pop up.
- Metric Files — Please note, in metric mode, all formula volume settings stored in the dispenser will be in liters. While the ILCS system allows programming in both milliliters and liters, Reporter can not convert dispenser formula volume settings from milliliters to liters. If you are to use Reporter to program dispensers, you can program pump volumes in liters only.

Note: Maximum memory in any one directory is 32,766 Bytes. the RM module must have adequate memory space for new files to save or file will not transfer. Delete files if necessary to provide enough free space for the new file.

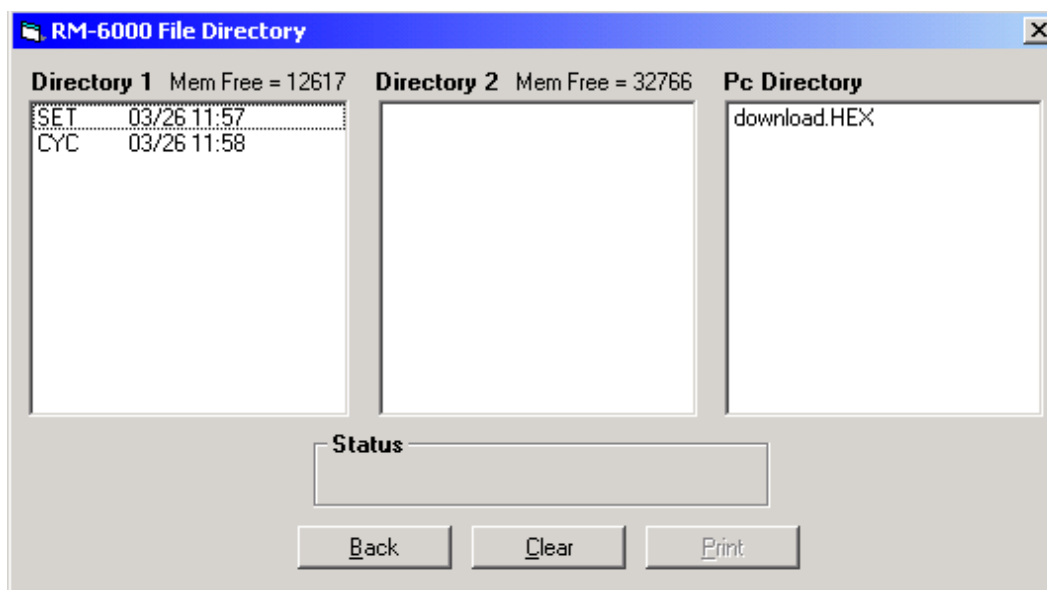

PRINTING REPORTS

- Make sure your PC and the ILCS system(s) have the correct time and date before printing.
- Make sure your PC has a default printer assigned or reports can not be viewed or printed.
- After transferring a setup (HEX) file to the ILCS system, you may wish to print the setup report from the system and review all settings to verify accuracy.

Creating New Reports

- (1) Logon to the ILCS system, then click Reports.
- (2) When you see the display to the upper right, click New.
- (3) When you see the display to the lower right, choose the report parameters detailed in the list below.
- (4) Click OK — when the program has completed printing the report, it will be saved in the Reports directory, or sent to the PC's printer (depending on the report destination that was chosen).

Report Parameters

- Report Type:** Setup shows all dispenser settings. Summary shows a consolidated chemical usage report. Batch shows a historical tracking of the actual batches dispensed. You can also choose if you wish to see batch errors.
- Include Cost:** Choose if you wish to have product costs shown on the report (not available for batch only reports).
- Report Dates:** Select the time span that the report will cover, using month/day format (not available for setup only reports). Date range cannot cross over a year end.
- Destination:** Select PC File to save the report as a file on your PC. Use this option if you do not have a printer connected to your PC and/or you simply wish to view the report on your screen. This option can also be used to create a library of reports for later analysis. Select PC Printer to print report directly without creating a file.
- Output File:** If you chose to print as a file, you will need to enter a name for the output file that will be created (no more than 6 characters). The program will automatically add the system's ID number to your file name, and will create the file with an extension of .RPT.
- Dispenser(s):** Select which dispenser you would like to print from by double-clicking the box next to its name. If you have a multilinked network of dispensers, you can click Select All.

Report Files

When you create report files (RPT) they are stored on your PC by customer location. This helps to keep reports organized for different accounts. If you change customer locations, then you will only see reports for the selected location when you open the reports menu. To work with your report files, click the Reports button. When you see the display to the upper right, click once on the file name, then choose from the options below.

- Print:** Allows you to print the selected report file. Print job will be sent to your PC's default printer.
- View:** Opens the selected report file for viewing. There are various navigation buttons in the report viewer that allow you to move from page to page, adjust zoom percentage, and to print the report.
- Export:** This feature allows you to export the selected report file into an Excel spreadsheet, or you can merge multiple report files into a single spreadsheet. Your computer must have Microsoft Excel (version 97 or higher) for this function to work correctly. See page 22 for more details.
- Delete:** Click this button if you wish to delete the selected report file. Be aware that this feature removes the file from your PC completely and does not send the file to Windows "Recycle Bin".

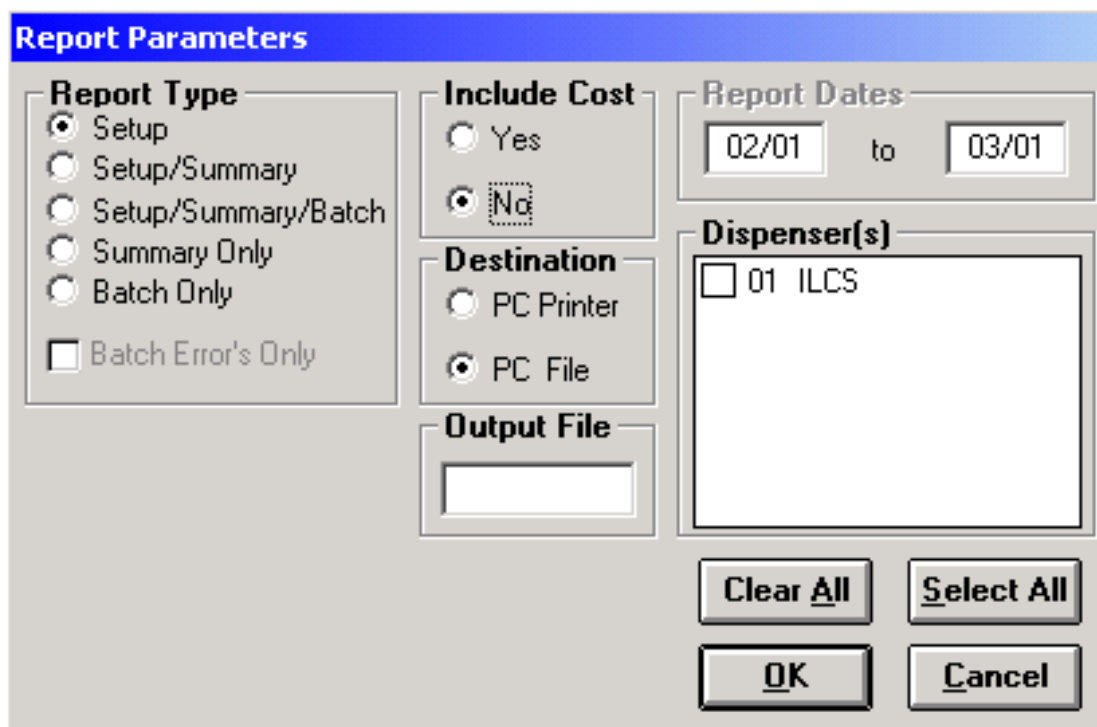

SPREADSHEET FUNCTIONS

The Export function in the Reports menu allows you export a single report file into a Microsoft Excel spreadsheet, or merge multiple report files into a single spreadsheet (if merging reports from different ILCS versions it is recommended that the pump names and formula names match).

Exporting Single Report

- (1) Click the Reports button.
- (2) Click once on the desired report file (RPT) to select it, then click Export.
- (3) When you see the display to the lower right, you may change any of the Print/Preview Chart options (detailed below) if desired.
- (4) The Export File name will be generated automatically. If you wish to change the name and/or destination of the Export File, click the lower Browse button and make any changes.
- (5) Click Process Reports.

Merging Multiple Reports

- (1) Click the Reports button, then click Export (do not select any files from the Reports window).
- (2) When you see the display to the lower right, click on the Browse button in the Report File(s) box.
- (3) Hold down the CTRL button on your keyboard, then click each file you wish to merge.
- (4) The Export File name will be generated automatically. If you wish to change the name and/or destination of the Export File, click the lower Browse button and make any changes.
- (5) Click Process Reports.

Print/Preview Chart Options

The following options allow you to choose what action will take place once the file is exported. They do not affect how the file(s) will be exported.

- Export — This option will generate a spreadsheet without printing or previewing, thus saving time if it is not necessary to view charts immediately after exporting.
- Print — When this option has been selected, the spreadsheet will be printed immediately after exporting.
- Preview — When this option has been selected, spreadsheet is displayed on the screen when the export is complete. The pull down menu located just above this option allows you to select which portion of the spreadsheet will be shown in the preview.

Spreadsheet Format

- Formula Volume Settings — Shows pump volumes for each formula.
- Pump Product Information — Shows pump flow rates and product cost settings.
- Total Batches and Product Cost — Shows total batches and product cost per shift and sum total.
- Product Usage — Shows amount and cost of each product for each shift.
- Batch Tracking — Shows actual batches that were dispensed, and the user's ID number.
- Sanitation Cost Analysis — Allows you to enter and manipulate numbers to calculate plan costs and variances.
- Batch Errors — Shows a listing of any errors that occurred while the system was in use.

Note: For merged spreadsheets, only the Total Batches and Product Costs, Sanitation Cost Analysis, and Product Usage are shown.

Load, Merge and Export to Spreadsheet

Report File(s)
C:\KNIGHT\ILCS WINREPTR\DATA\KC\TEST1.RP **Browse...**

Export File
C:\KNIGHT\ILCS WINREPTR\DATA\KC\TEST1.XL **Browse...**

Print/Preview Chart
Total Batches and Product Cost **Process Reports**

Export **Print** **Preview**

Close

MODEM SETUP

When you install Knight Reporter software, there is also a modem interface software that installs automatically. This program allows you to use your “on-site” PC as a modem connection for the ILCS system. Logging on from a remote PC is done using the “via modem” option.

Running Modem Interface Software

- (1) Click on the modem interface software icon on your desktop.
- (2) The software will automatically “look” for the Knight Reporter cable, as well as the modem and computer interface device that is being used to connect to the dispenser network.
- (3) When all device checking is done and the program is running normally, the status box shows “Waiting for Call”.
- (4) You can minimize the Modem Interface display if you wish to run other programs on the PC while the modem interface software runs in the Windows background.

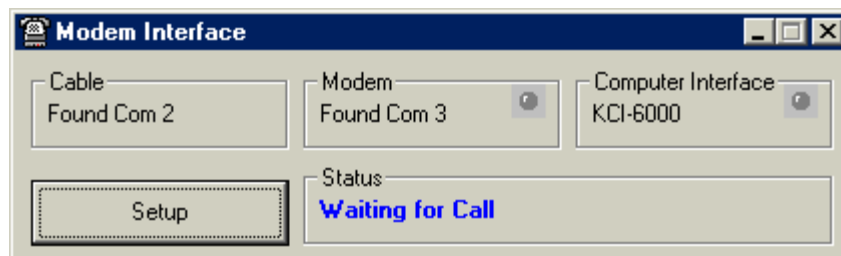

Modem Interface Configuration Settings

The Setup button allows you to make configuration changes for the modem interface software. Be sure to click OK when you are done.

- Access Code — This is an extra level of protection to prevent unauthorized users from logging onto the ILCS system. You will be prompted for this code when logging on (via modem) from the remote PC.
- Language — You can choose between English and Spanish to change the Modem Interface display.
- Modem Init — This initialization string is pre-configured to work properly on most PC's. If the modem interface software is not working properly, check your modem documentation to verify if there is a different string required.

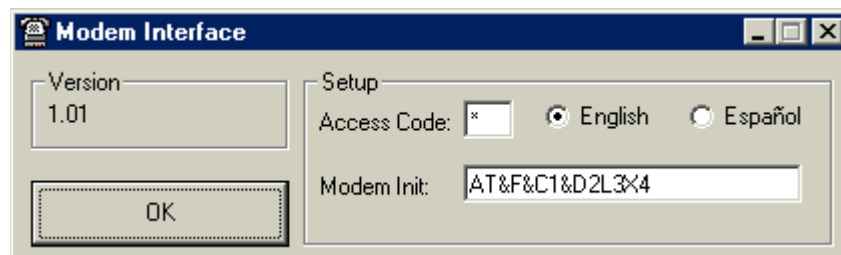

Setting up the remote PC

The remote PC must be configured properly to allow dialing up the ILCS system. The modem on the remote PC can be either an internal or external modem, however you will need to know which com port your modem is using (you may need to check your PC documentation to find this information).

- (1) Click Setup (from the pull-down menus at the top) then Modem.
- (2) When you see the display below, choose the correct com port number.
- (3) Baud rate settings: 9600 recommended if RM is on the other end, 2400 for KCI.
- (4) The initialization string should be acceptable for most modems, however if you need to change this setting, consult your modem documentation and enter the correct information in the box.
- (5) When all information is entered, click OK.

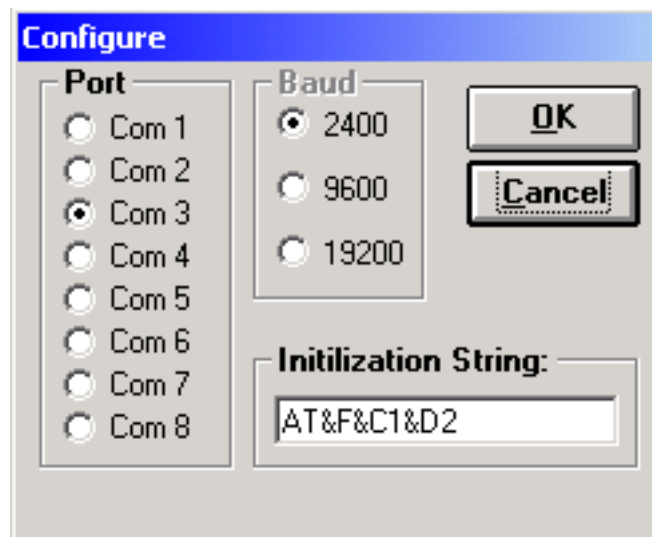

The image shows a 'Configure' dialog box with a blue title bar. It contains three main sections: 'Port', 'Baud', and 'Initialization String'. The 'Port' section has radio buttons for Com 1 through Com 8, with Com 3 selected. The 'Baud' section has radio buttons for 2400, 9600, and 19200, with 2400 selected. The 'Initialization String' section has a text box containing 'AT&F&C1&D2'. There are 'OK' and 'Cancel' buttons on the right side.

Section	Option	Selected
Port	Com 1	<input type="radio"/>
	Com 2	<input type="radio"/>
	Com 3	<input checked="" type="radio"/>
	Com 4	<input type="radio"/>
	Com 5	<input type="radio"/>
	Com 6	<input type="radio"/>
	Com 7	<input type="radio"/>
	Com 8	<input type="radio"/>
Baud	2400	<input checked="" type="radio"/>
	9600	<input type="radio"/>
	19200	<input type="radio"/>
Initialization String	AT&F&C1&D2	

OTHER FEATURES

Version Identification

To see the version of WinReporter software you have, click Help (from the pull-down menus at the top) then click About WinReporter. The PC software version will be shown. If you are logged onto an ILCS system when using this feature, then you will also see version numbers of the dispenser and external memory module. This information may be helpful if you need to contact Technical Support for assistance.

Setting External Memory Module ID

External Memory module functions apply to version 2.00 and higher ILCS systems. Disregard for 1.xx versions.

The external memory module has an ID number just like the ILCS system. When a new unit is shipped from the factory, all ID numbers will be zero by default. If the ILCS system ID number is ever changed, then the External Memory module ID must be changed for data to be properly tracked.

- (1) Click Setup (from the pull-down menus at the top) then click Ext. Memory Module.
- (2) When you see the display below it will show what the current memory module ID is. Enter the new ID number and click Update.

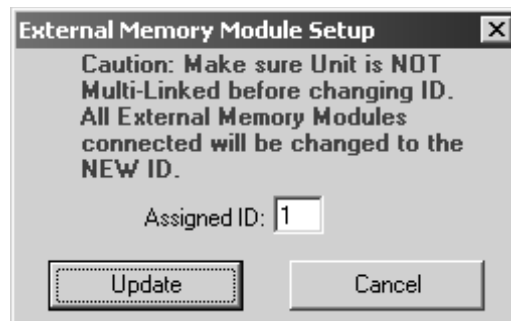

Clearing External Memory Module

The External Memory Module can hold a very large amount of data and typically does not need to be cleared. However, if you are installing a new system or simply wanting to get rid of old unused data, you can clear the memory of the module following the steps listed below.

- (1) Logon to the ILCS system.
- (2) Click Setup (from the pull-down menus at the top) then click Clear Settings.
- (3) When you see the display below, click Memory Module then click OK.

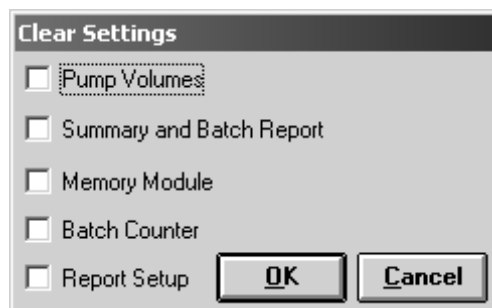

Notes

DISCLAIMER / WARRANTY

Knight LLC does not accept responsibility for the mishandling, misuse, or non-performance of the described items when used for purposes other than those specified in the instructions. For hazardous materials information consult label, MSDS, or Knight LLC. Knight products are not for use in potentially explosive environments. Any use of our equipment in such an environment is at the risk of the user, Knight does not accept any liability in such circumstances.

All Knight controls and pump systems are warranted against defects in material and workmanship for a period of ONE year. All electronic control boards have a TWO year warranty. Warranty applies only to the replacement or repair of such parts when returned to factory with a Knight Return Authorization (KRA) number, freight prepaid, and found to be defective upon factory authorized inspection. Bearings and pump seals or rubber and synthetic rubber parts such as "O" rings, diaphragms, squeeze tubing, and gaskets are considered expendable and are not covered under warranty. Warranty does not cover liability resulting from performance of this equipment nor the labor to replace this equipment. Product abuse or misuse voids warranty.

KNIGHT LLC, A Unit of IDEX Corporation

World Headquarters
20531 Crescent Bay Drive
Lake Forest, CA 92630
Tel: 949.595.4800
Fax: 949.595.4801
www.knightequip.com

USA Toll Free
Tel: 800.854.3764
Fax: 800.752.9518

Canada
Tel: 905.542.2333
Fax: 905.542.1536

Australia
Tel: 61.2.9725.2588
Fax: 61.2.9725.2025

UK
Tel: 44.1293.615.570
Fax: 44.1293.615.585

North Europe
Tel: 31.53.428.5800
Fax: 31.53.428.5809

South Europe
Tel: 34.93.487.1015
Fax: 34.93.215.2019

North Asia Pacific
Tel: 82.2.3481.6683
Fax: 82.2.3482.5742

Southeast Asia
Tel: 65.9170.0984
Fax: 65.6489.6723
